







20 000 705 Product version from 3/9/2015

- hole diameter valve 32 mm
- rosette 60 x 60 mm
- with cold marking
- WRAS



	Chrome	20 000 705-00
	Brushed Platinum	20 000 705-06
	Dark Chrome	20 000 705-19
	Brushed Champagne (22kt Gold)	20 000 705-46
	Champagne (22kt Gold)	20 000 705-47
	Brushed Dark Platinum	20 000 705-99

20 000 705 Product version from 3/9/2015

mm [inches]

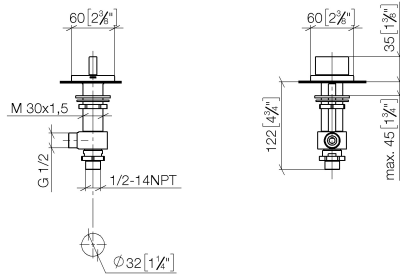

**Flow rate chart**



**Codes & Standards**

ASME A112.18.1	cUPC	DIN 4109	ISO 3822
Scottish Water Byelaws	UK Water Supply Regulations	Ü-Zeichen	



## CL.1 Deck valve clockwise closing cold - Chrome

---

CL.1

20 000 705 Product version from 3/9/2015

### Certificates and sustainability

---

IAPMO\_4976

WRAS\_2103

LGA\_28

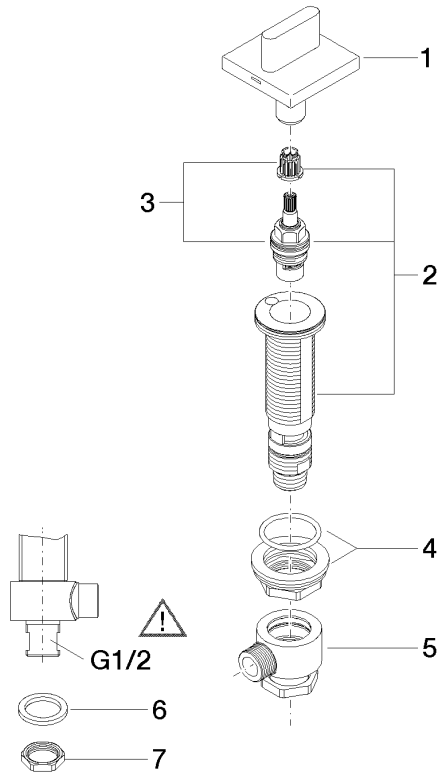

Spare parts list

No.	Item Number	Name	Quantity used	Delivery time
3	90 90 03 133 00 90	top	1.00	2
5	04 17 11 023 10 90	distributor	1.00	2
8	09 23 10 012 90	nut	1.00	2
2	04 17 11 058 33 90	side panel	1.00	2
7	09 30 11 059 90	disc	1.00	2
4	04 23 10 032 78 90	fixing set	1.00	2
1	90 20 70 051 04-00	handle ( cold )	1.00	10
6	90 23 30 040 00-00	threaded connector	1.00	10