







20 005 705 Product version from 3/9/2015



- with WAVES structure
- hole diameter 32 mm
- rosette 60 x 47 mm
- with cold marking
- WRAS

	Chrome	20 005 705-00
	Brushed Platinum	20 005 705-06
	Dark Chrome	20 005 705-19
	Brushed Champagne (22kt Gold)	20 005 705-46
	Champagne (22kt Gold)	20 005 705-47
	Brushed Dark Platinum	20 005 705-99

20 005 705 Product version from 3/9/2015

mm [inches]

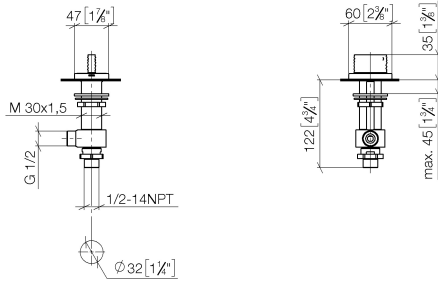

Flow rate chart



Codes & Standards

ASME A112.18.1	cUPC	DIN 4109	ISO 3822
NSF372	NSF61	Scottish Water Byelaws	UK Water Supply Regulations

Ü-Zeichen



CL.1 Deck valve clockwise closing cold - Chrome

CL.1

20 005 705 Product version from 3/9/2015

Certificates and sustainability

IAPMO_N-4

LGA_28

IAPMO_4976

IAPMO_6

WRAS_240202

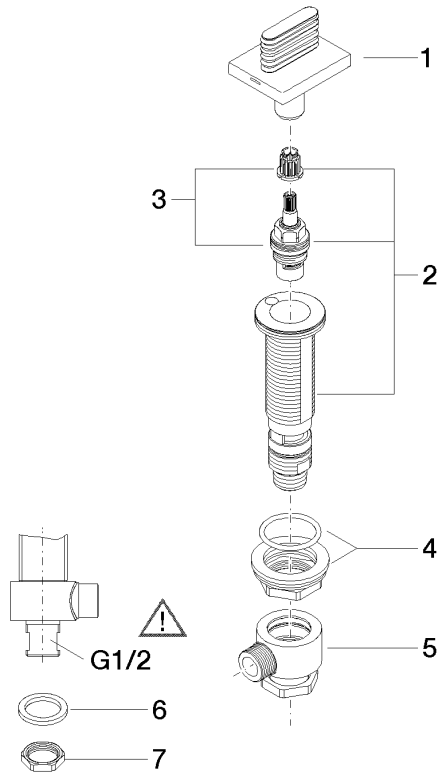

Spare parts list

No.	Item Number	Name	Quantity used	Delivery time
8	09 23 10 012 90	nut	1.00	2
2	04 17 11 058 53 90	side panel	1.00	2
1	90 20 70 055 06-00	handle (cold)	1.00	10
3	90 90 03 153 00 90	top	1.00	2
5	04 17 11 023 10 90	distributor	1.00	2
4	04 23 10 032 78 90	fixing set	1.00	2
7	09 30 11 059 90	disc	1.00	2
6	90 23 30 040 00-00	threaded connector	1.00	10