

MEDA

Bathtub, back-to-wall version, made of Marbond composite material

DIMENSIONS

| | |
|--------|---------|
| Length | 1800 mm |
| Width | 800 mm |
| Height | 590 mm |

COLOUR AND FINISH

000 White

OPTIONS

000 - standard option

SPECIFICATION TEXT

Bathtub made of Marbond glossy surface
Back to wall version, with one piece panel with integrated overflow with click-clack waste and Marbond cover with feet for bathtub
Charge 000 – without whirl system

MOUNTING ACCESSORIES INCLUDED

click-clack waste with Marbond cover , order no. 29513.7
Flex-pipe 1m, order no. 29443.9
Feet for bathtub, order no. 29617.9

MOUNTING ACCESSORIES EXCLUDED

Noise control band, order no. 29555.1

Drain : Included

Installation structure : With feet

Installation type : Back to wall

Internal height (mm) : 1235

Material : Marbond

Net weight (kg) : 134

Shape : Oval

Waste diameter (mm) : 52

Water capacity to overflow (l) : 260

TECHNICAL DRAWINGS

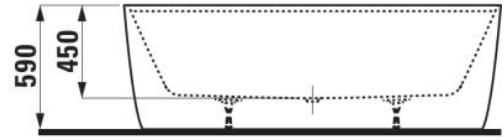
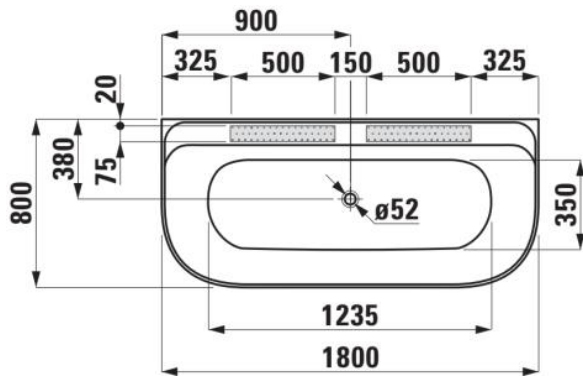

COMPATIBLE WITH



Neck cushion, black, self-adhesive, for curved bathtub contours

H294103...0001

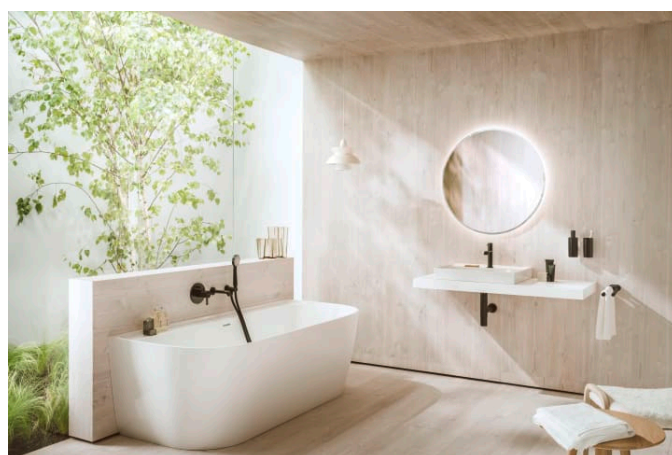

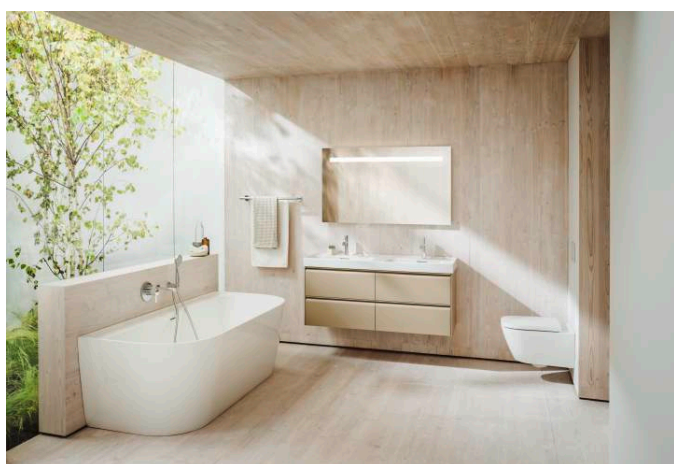
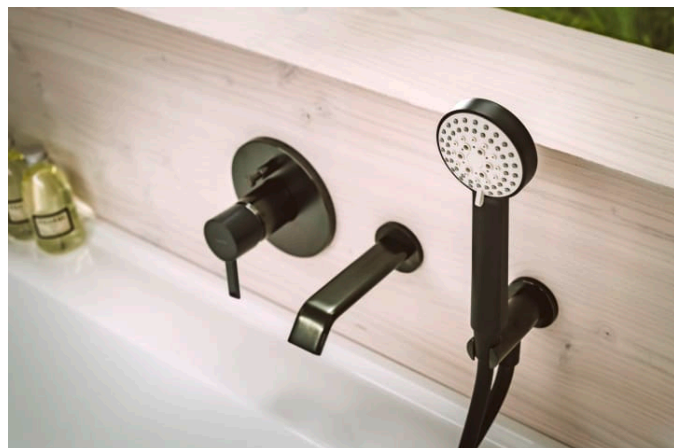



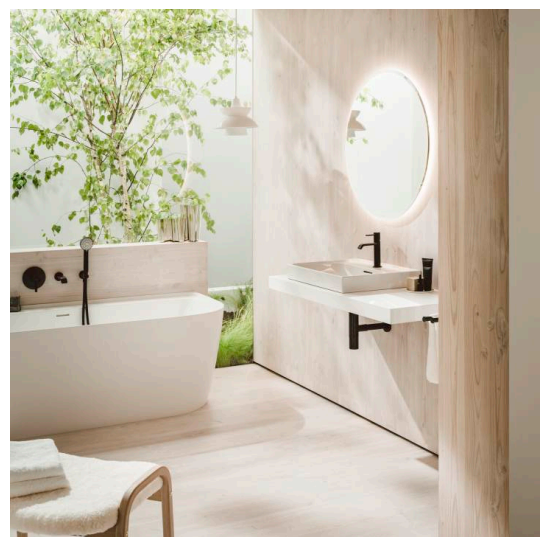
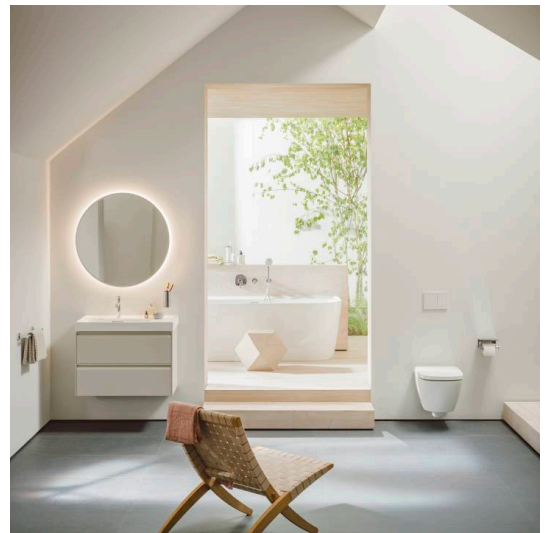
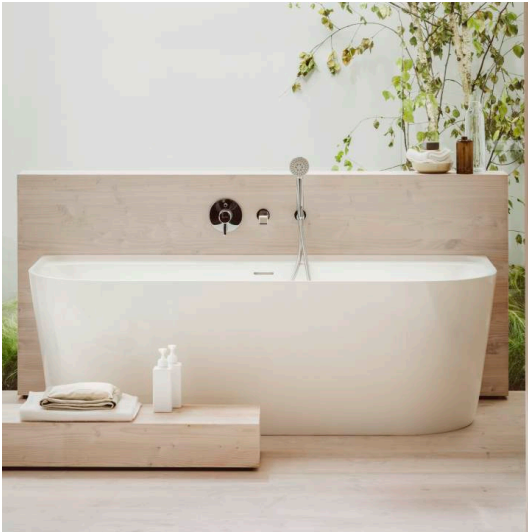

MEDA

Versatile and timeless. The MEDA collection effortlessly complements any setting, from rental apartment to hotel suite, while reflecting the proven virtues of Swiss design; clarity, functionality and attention to detail. A style emblematic of Swiss designer Peter Wirz and his design firm Vetica.



#material_text

MARBOND

Marbond

Marbond is a composite material made of two layers which are extremely well connected with each other: The basis is formed by a high-quality mineral casting material, the surface is coated with a two millimetre thick acrylic layer. Marbond is hygienic, easy to clean, temperature resistant according to EN 263 and anti-slip (class C).